

ROCKER SWITCHES

DS-850 SERIES



DS-850シリーズ照光式波動 DS-850 SERIES ILLUMINATED



U L UL® 【File No. E43907】
 CSA SP 【File No. LR26920】
 VDE D'E 【File No. 93570】

取付穴参考寸法
Mounting Hole Dimensions

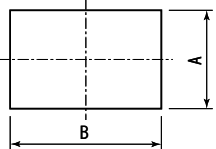

パネル板厚 Panel Thickness	A 寸法 A Size	B 寸法 B Size
1mm	13 ^{+0.2} ₀ mm	19.1 ^{+0.2} ₀ mm
1.5mm		19.2 ^{+0.2} ₀ mm
2mm		19.4 ^{+0.2} ₀ mm
2.5mm		19.6 ^{+0.2} ₀ mm

品番 PARTS NO.	回路 CIRCUIT	スイッチ特性 SWITCHING FUNCTION	電流容量 RATING	絶縁抵抗 INSULATION RESISTANCE	絶縁耐圧 VOLTAGE BREAKDOWN	接触抵抗 CONTACT RESISTANCE
DS-850K-S-□ DS-850K-F1-□ DS-850K-RI-□	SPST (2P)	ON-OFF	5A. 125V. AC 3A. 250V. AC 3/250~T85	DC. 500V 100MΩ以上 (MIN)	AC. 2000V 1分間 (Minute)	20mΩ以下 (MAX)
DS-850S-F2-□	DPST (4P)		10A. 250V. AC			
DS-850K-F3-□ DS-850S-F3-□	SPST (2P) DPST (4P)		5A. 125V. AC 3A. 250V. AC 3/250~T85			
DS-850A-S-00 DS-850A-F1-00	SPDT (3P)	ON-ON	5A. 125V. AC 3A. 250V. AC	DC. 500V 100MΩ以上 (MIN)	AC. 1500V 1分間 (Minute)	
DS-850C-S-00 DS-850C-F1-00	SPDT (3P)	ON-OFF-ON				
DS-850K-S-□ (LED) DS-850K-F1-□ (LED)	SPST (2P)	ON-OFF	5A. 125V. AC 3A. 250V. AC			

DS-850シリーズ/SERIES

ご注文の際は下記の例に準じてご用命下さい。

ORDERING INFORMATION

DS-850 S - F3 - N1 - K - T-R
 1 2 3 4

* 注記 NOTE

ネオン照光 NEON ILLUMINATED	
T-R	透明赤 Clear Red
T-G	透明緑 Clear Green
T-O	透明橙 Clear Orange

1		2		3		4		
回路 CIRCUIT	スイッチ特性 SWITCHING FUNCTION	端子形状 SHAPE of TERMINAL		操作部 SHAPE of OPERATION PART		本体、ツマミ KNOB & CASE	カラー COLOR	
						K	N	W
K	ON-OFF SPST (2P)	S	ハンダ端子 Solder Terminal	OO	無印 withoutSymbol 点入り withSymbol-Dot ON-OFF表示 withSymbol-ON-OFF IO表示 withSymbol-I-O	○	○	△
		F1	タブ端子 #110 Tab Terminal	WD ON		○	△	×
		RI	ライトアングル端子 Right Angle Terminal	I O		○	×	×
S	ON-OFF DPST (4P)	F2	タブ端子#187 t=0.5 Tab Terminal #187t=0.5	OO WD	無印 withoutSymbol 点入り withSymbol-Dot ON-OFF表示 withSymbol-ON-OFF IO表示 withSymbol-I-O	○	△	△
		F3	タブ端子#187 t=0.8 Tab Terminal #187t=0.8	ON I O		○	△	△
A	ON-ON SPDT (3P)	S	ハンダ端子 Solder Terminal	OO	無印 withoutSymbol	○	△	×
C	ON-OFF-ON SPDT (3P)	F1	タブ端子 #110 Tab Terminal #110			○	△	×
LED照光スイッチ LED ILLUMINATED SWITCHES								
K	ON-OFF SPST (2P)	S	ハンダ端子 Solder Terminal	LR	赤 Red 黄 Yellow 緑 Green	○	○	×
		F1	タブ端子 #110 Tab Terminal #110	LY LG		○	△	×
ネオン照光スイッチ NEON ILLUMINATED SWITCHES								
K	ON-OFF SPST (2P)	F3	タブ端子#187 t=0.8 Tab Terminal #187 t=0.8	N1	125V用 ネオン球付 with Neon 125V type	○	△	×
S	ON-OFF DPST (4P)			N2	250V用 ネオン球付 with Neon 250V type	○	△	×

注記 (NOTE)

○=標準色 Standard Color

△=受注生産 Only for large quantity order

本体・ツマミ・カラー KNOB & CASE COLOR		
K	黒	Black
N	グレー	Gray
W	白	White

ハンダ付不可 Do not solder	
F2	タブ端子#187 t=0.5 Tab Terminal #187 t=0.5
F3	タブ端子#187 t=0.8 Tab Terminal #187 t=0.8

* 端子形状F3タイプはVDE規格上では半田端子区分になります。

* Terminal Shape 'F3 Tab' belongs to the classification of 'solderterminal' on the VDE standards.

DS-850シリーズ / SERIES

外形図 / Dimensions

DS-850K-S-□

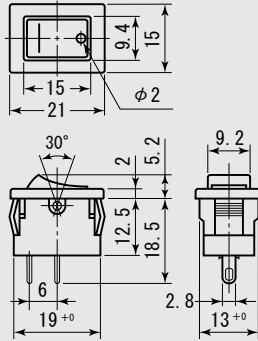

DS-850K-S-WD

DS-850K-F1-□

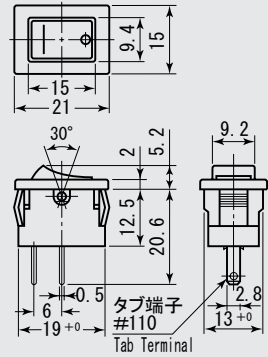

DS-850K-F1-WD

DS-850K-RI-□

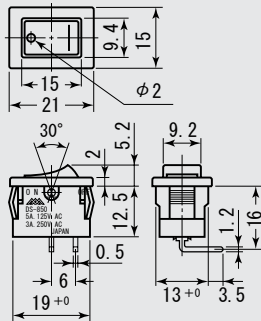

DS-850K-RI-WD

DS-850S-F2-□

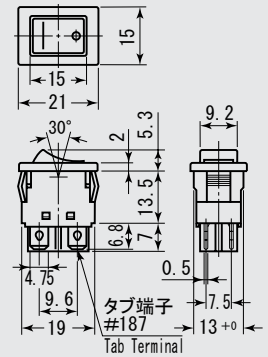

ハンダ付不可
Do not solder

DS-850S-F2-WD

DS-850C-S-□

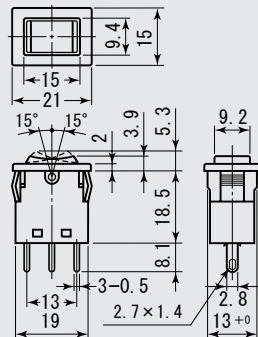

DS-850C-S-OO

DS-850S-F3-□

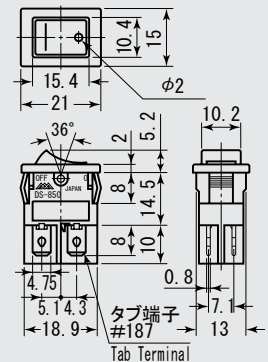

ハンダ付不可
Do not solder



DS-850S-F3-WD

DS-850シリーズ / SERIES

LED照光式 / LED ILLUMINATED SWITCHES

DS-850K-S-LR

(with LED) **LY**
LG

UL Listed
CSA

(Available with  Mark™)

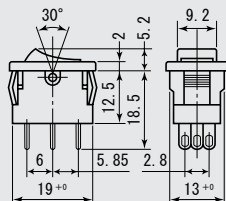
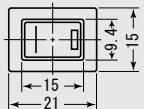

DS-850K-F1-LR

(with LED) **LY**
LG

UL Listed
CSA

(Available with  Mark™)

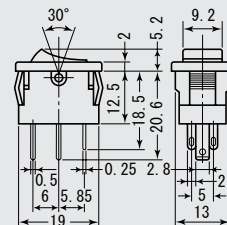
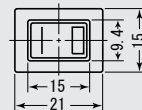

LED仕様 Specifications

絶対最大定格 (周囲温度Ta=25°C)

Absolute maximum ratings

Ta=25°C

Color	Pd (mW)	IF (mA)	IFM (mA)	VR (V)	Topr (°C)	Tstg (°C)
Red	80	40	300	4	-30	-30
Yellow	100		100		~	~
Green	100		100		+85	+100

動作特性 (順電流IF=20mA, 周囲温度Ta=25°C, 逆電圧Vr=4V)

Electro-optical characteristics IF=20mA, Ta=25°C, Vr=4V

Color	VF (Typ.) (V)	IR(Max) (μA)	IV(mcd)		λP (Typ.) (nm)	Δλ (Typ.) (nm)
			Min.	Typ.		
Red	1.7	100	12	24	660	30
Yellow	2.1	100	10	15	570	30
Green	2.1	100	2	4	555	30

DS-850シリーズ / SERIES

照光式 (ネオン) / NEON ILLUMINATED SWITCHES

DS-850K-F3-N1-K-TR

(with Neon)



CIRCUIT

DS-850K-F3-N1 or N2

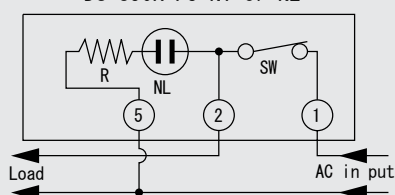

DS-850S-F3-N1 or N2

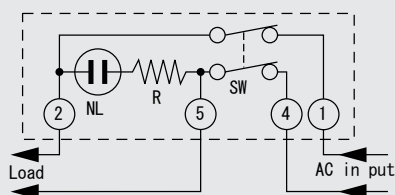

ランプ回路表示
Lamp Circuit View

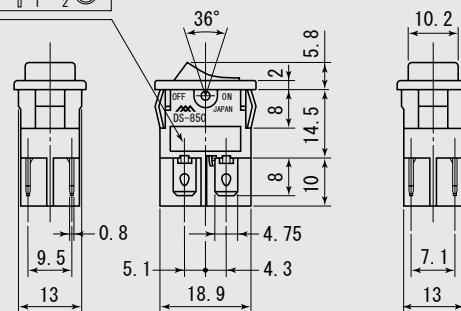
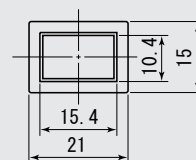
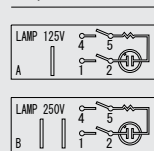

DS-850S-F3

 ハンダ付不可
Do not solder

